

FUMEX®

APS

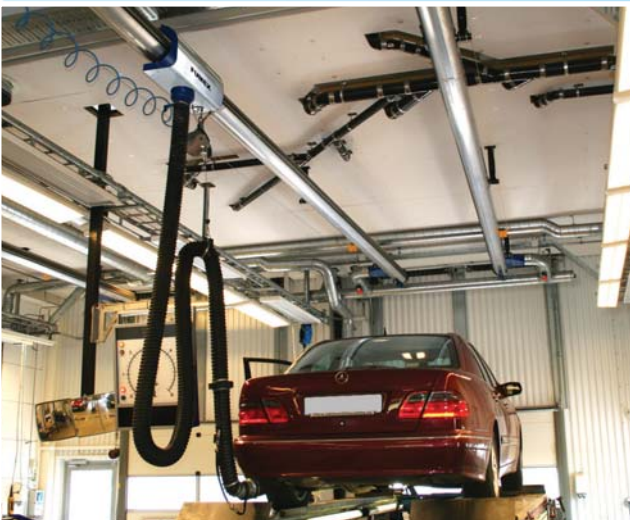

Exhaust fume rail for worksites with moving vehicles.

APS is the optimal solution for moving vehicles.

The unique design of the profile rail has distinct advantages for installation, during use and for maintenance:

- The market's lowest pressure drop means low operating costs.
- A rubber flap naturally seals the air gap, minimising leaks.
- Simple fitting of the rubber flap.
- Flexibility, the option of different hose lengths and qualities.
- Profile edge on the rear of the rail makes fitting simpler.

Vertical hose suspended in balancing block, available in four dimensions in the standard length of 5 m. Longer hoses are available on request.

APS has manual disconnection/return on the standard design, but has automatic disconnection/return with compressed air nozzle as optional. Can also be equipped with various fan and damper controls.

The rail is connected to a separate fan or central exhaust system.

The trolley can be equipped with a PR extractor point as an option.

The Fumex range also includes fans, accessories and control devices suitable for exhaust extractors

EXHAUST EXTRACTOR
Pure advantage

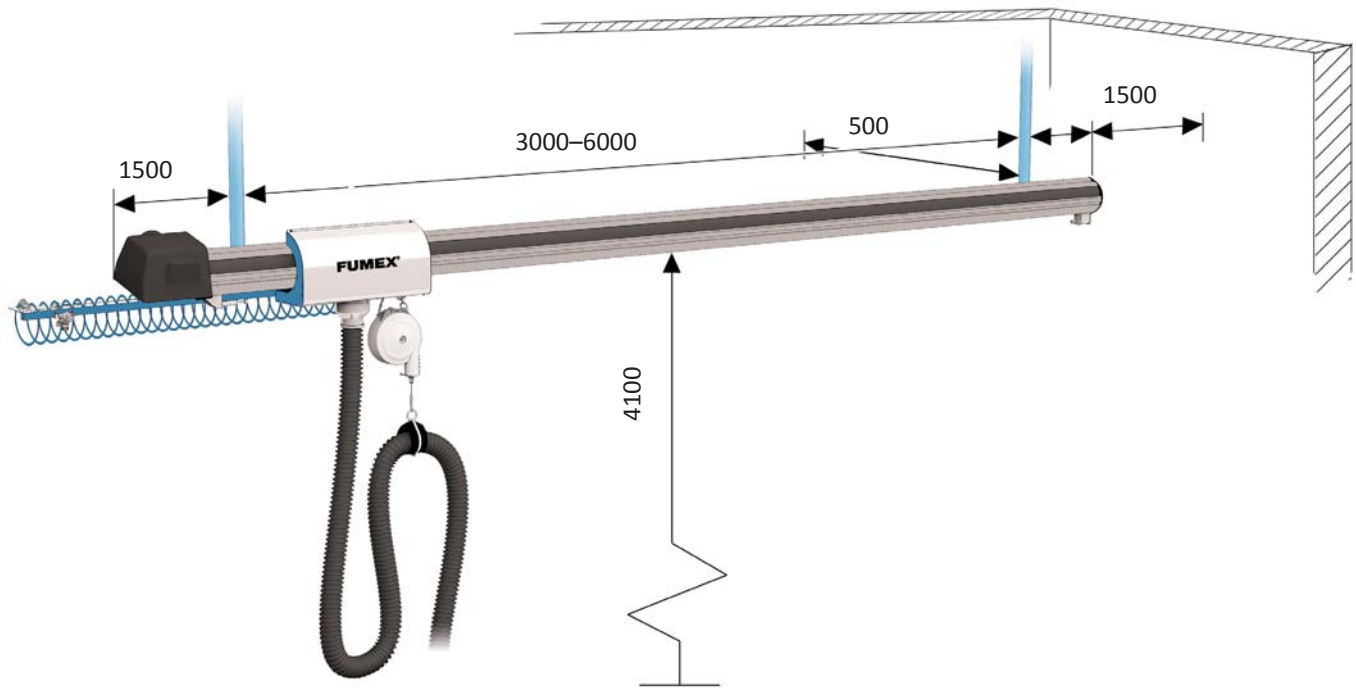

Manual nozzle disconnection

Exhaust fume rail with manual disconnection used primarily for low frequency throughflow of vehicles, plus for entry/exit through the same gate.

The trolley is connected at the entrance and follows the vehicle to the exit, where it is manually disconnected.

Hose and nozzle, suspended in a balancing block with catch, can be adjusted vertically.



Automatic nozzle disconnection

Automatic nozzle disconnection is primarily for private cars, where the nozzle is manually connected, and is controlled by compressed air. The nozzle is activated by a slide valve, positioned on the hose above the pneumatic nozzle. When a vehicle is driven to the exit, a limiter breaks the airflow to the nozzle which then releases from the exhaust pipe, and the balancing block pulls the hose back to the upper level.

The balancing block which pulls up the nozzle and hose is available in various designs, including with pneumatic brake and for different weight loads.



Exhaust fume rail with automatic trolley return

Automatic trolley return is used for high frequency throughflow of vehicles, such as in vehicle inspection workshops.

When a manual connection is made, the nozzle accompanies the vehicle to the exit. Disconnection there is either automatic or manual. A sensor at the exit is activated when the trolley is in the position for return. An adjustable time delay setting allows the nozzle and hose time to get to the return transport position. The return is run by a variable speed electrical motor with a closed line system connected to the trolley. Once back in the starting position, a limiter stops the trolley in the home position.

This solution includes the control cabinet with automatic control unit.

All systems are available with automatic fan start/stop via remote control, plus control of automatic dampers, etc.

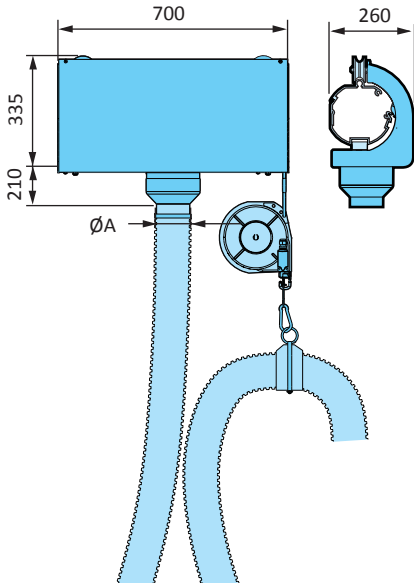

Trolley for manual and automatic nozzles

Trolley, powder coated steel and stainless cover plate with ball-bearing guide wheel. Supplied complete with: AG hose, 5m, crushable with EPDM rubberised fabric, in dimensions 75, 100, 125 or 150 mm with a max temperature of 170 °C.

Balancing block:

Manual: Steel plate/aluminium med 4.2 m wire.

Automatic control device: Reinforced polyamide, inversely progressive.

Available for left (L) and right (R) fitted profile rails.

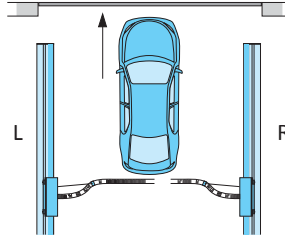

Manual trolley nozzle

Item No.	Description	Dimension
APS 507 M/L	Left fitted	Ø 75 mm
APS 507 M/R	Right fitted	Ø 75 mm
APS 510 M/L	Left fitted	Ø 100 mm
APS 510 M/R	Right fitted	Ø 100 mm
APS 512 M/L	Left fitted	Ø 125 mm
APS 512 M/R	Right fitted	Ø 125 mm
APS 515 M/L	Left fitted	Ø 150 mm
APS 515 M/R	Right fitted	Ø 150 mm

Automatic trolley nozzle

Item No.	Description	Dimension
APS 507 A/L	Left fitted	Ø 75 mm
APS 507 A/R	Right fitted	Ø 75 mm
APS 510 A/L	Left fitted	Ø 100 mm
APS 510 A/R	Right fitted	Ø 100 mm
APS 512 A/L	Left fitted	Ø 125 mm
APS 512 A/R	Right fitted	Ø 125 mm
APS 515 A/L	Left fitted	Ø 150 mm
APS 515 A/R	Right fitted	Ø 150 mm

Ceiling bracket, wall bracket and strut

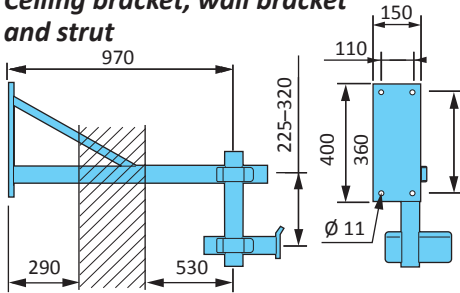

Wall bracket, adjustable

Powder coated steel. Max length 1.0 m. The bracket sections are joined using Layher connectors.

Weight: 12.3 kg

Wall bracket

Item No.	Description	Length
APS 210	Adjustable wall bracket	max 1000 mm

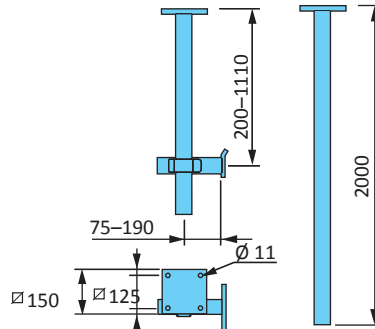

Ceiling bracket, adjustable

Powder coated steel. Adjustable length, 140–2000 mm. The bracket sections are joined using Layher connectors.

Weight: 1000 mm – 7.6 kg, 2000 mm – 10 kg

Ceiling bracket

Item No.	Description	Length
APS 200	Adjust. ceiling bracket	max 1000 mm
APS 205	Adjust. ceiling bracket	max 2000 mm

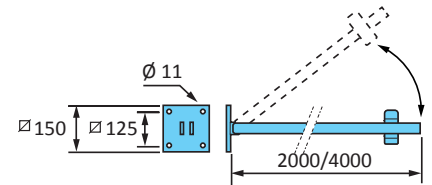

Strut, ceiling or wall fixing

Powder coated steel. Length 2 or 4 m. Turnable Layher connectors.

Weight: 2000 mm – 7.3 kg, 4000 mm – 13.4 kg

Strut

Item No.	Description	L
AS 222	Strut pipe with plate	2000 mm
AS 224	Strut pipe with plate	4000 mm

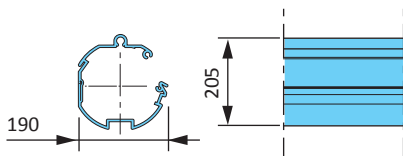

Profile rails

Made from anodised aluminium, with a track picture for simple fitting of the bracket and rubber strip. Available in metre intervals up to six metres.

Weight/metre: 6 kg

Profile rails

Item No.	Description	L
APS 300/60	Standard length	6 m
APS 300/30	Length	3 m
APS 300/10	Length	1 m

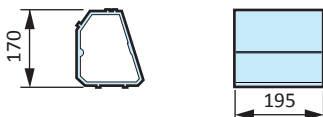

Joint

Anodised aluminium. Used for rail joints longer than six metres.

Weight: 1.2 kg

Joint

Item No.	Description
APS 310	Joint section

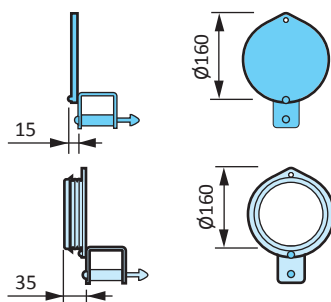

Gable with end stop

Powder coated steel. The end stop consists of a gas damper to capture the trolley.

Weight: 1.6 kg

Gable with end stop

Item No.	Description
APS 405	End stop with gas damper

Gable with duct connection

Powder coated steel. Duct connection Ø 160 mm. The end stop consists of a gas damper to capture the trolley.

Weight: 1.3 kg

Gable with duct connection

Item No.	Description
APS 415	End stop with duct connection

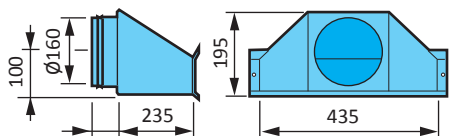

Duct connection for side fitting

Powder coated steel. Used for air exhaust at the side of the rail \varnothing 160 mm. Weight: 2.4 kg

Duct connection for side fitting

Item No.	Description
APS 420	Side duct connection

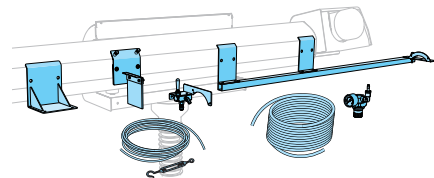

Compressed air unit

Compressed air unit for use with pneumatic nozzle. Nozzle not included, see separate leaflet.
APS 820/840M, for manual disconnection, contains wire, compressed air hose and pressure regulator 0.8 Bar.
APS 820/840A, for automatic disconnection, contains compressed air hose, pressure regulator 0.8 Bar, lever valve and limit warning.

Automatic control device

Item No.	Description	
APS 820M/L	Left rail	Wire 20 m
APS 820M/R	Right rail	Wire 20 m
APS 840M/L	Left rail	Wire 40 m
APS 840M/R	Right rail	Wire 40 m
APS 820A/L	Left rail	Wire 20 m
APS 820A/R	Right rail	Wire 20 m
APS 840A/L	Left rail	Wire 40 m
APS 840A/R	Right rail	Wire 40 m

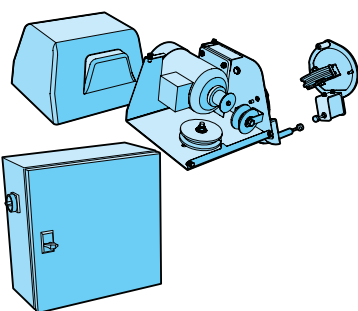

Return operation

Motor bracket in powder coated steel with cover in ABS plastic. Encapsulated control box. Motor 0.37 kW 230 V~.
 End piece in powder coated steel with ball-bearing wheel. Cable in spun nylon. Limiter switch complete with bracket and limit markings.
 Available for right (R) and left (L) fitted profile rails.
Control cabinet for regulating the return operation of exhaust van and fans. (Inverters must be selected separately, depending on fan size.)

Return operation

Item No.	Description
APS 925-L	Left rail
APS 925-R	Right rail

Control cabinet

Item No.	Description
AL 1	For one rail
AL 2	For two rails
AL 3	For three rails
AL 4	For four rails
AL 5	For five rails
AL 6	For six rails

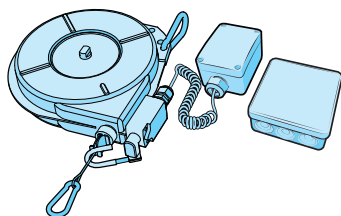

Controls

Fan and damper control via remote control
 Microswitch, emitter and receiver

Remote control

Item No.	Description
APS 965RC	Emitter, receiver, switch

Pressure drop

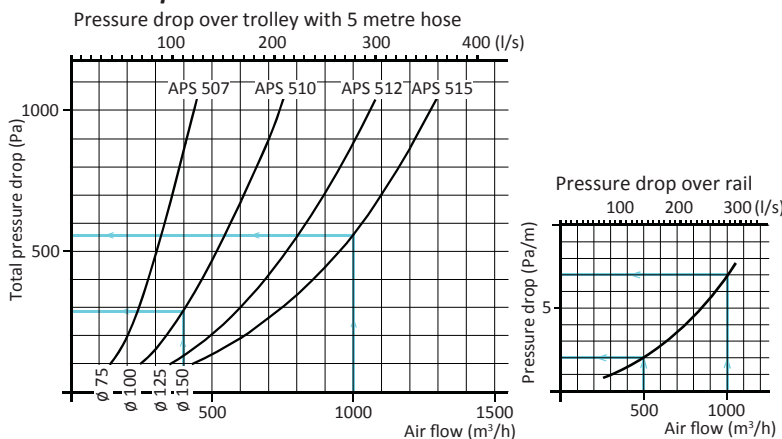

Recommended air flow

Vehicle	Air flow m³/h
Passenger cars	approx. 200-400
Lorries	approx. 600-1000
Air flow l/s	
Passenger cars	approx. 55-110
Lorries	approx. 165-278

Systems are normally designed for stationary vehicles, but the air flow should be selected higher than the stated exhaust gas flow. The system as a whole should be designed for a somewhat higher load than stated by minimum requirements.

Delivery

Adjustable fixings for easy installation.
 Nozzle to be purchased separately – see leaflet Exhaust Nozzle.
 Fans and fan controls are available in separate leaflets Fans and Control Units.

