

## GRILLE WITH ADJUSTABLE VANES A-130 • G-130

### Installation dimensions

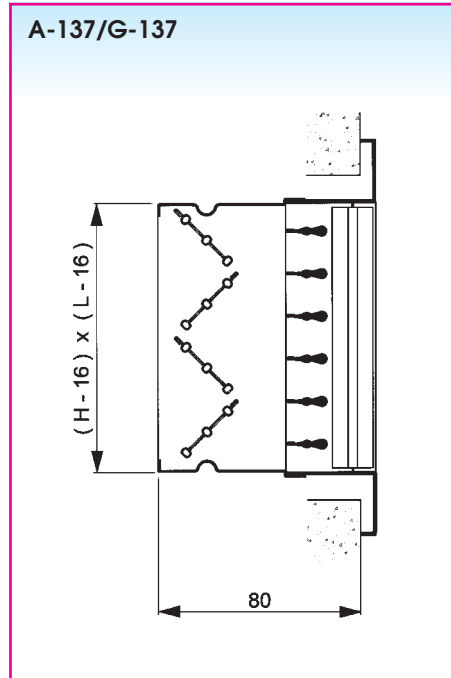
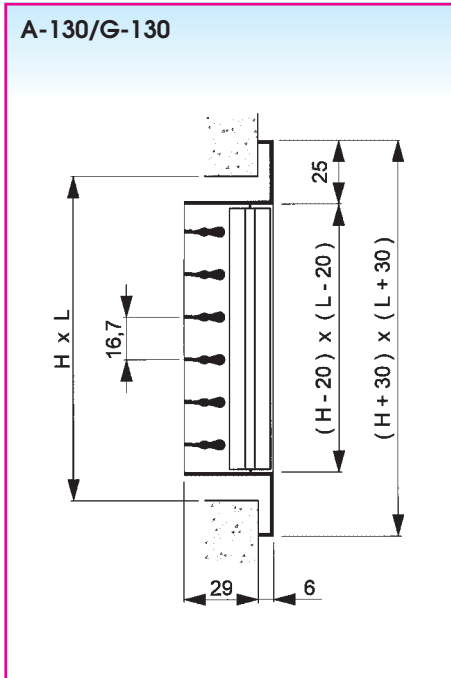

L = nominal length (mm)  
H = nominal height (mm)  
All dimensions in mm

### Fast selection diagram

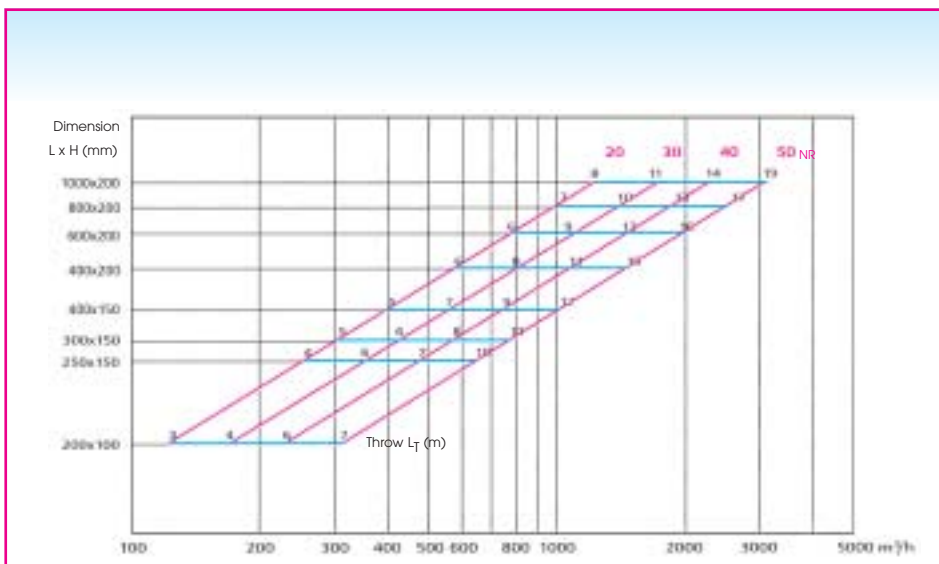

Valid for supply only. See diagram p. 1 050 for exhaust.  
Throw factor is based on a  $v_R$  of 0,17 m/s in the occupied zone.

See p. 1 050 for a detailed selection and other dimensions.

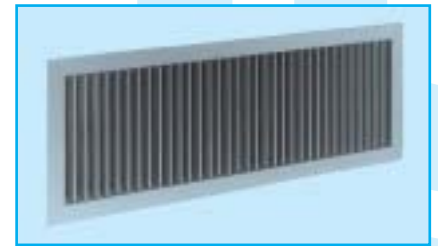

### Application

The grilles type A-130 / G-130 are used for the supply and exhaust of cooled and heated air in facilities such as offices, shopping centres, workshops, ...

The grille can be used for wall or exposed duct mounting.

It is also possible to mount the grille in the ceiling in order to create e.g. an air curtain (only with AE / GE and AF / GF).

The vertical and horizontal vanes can be adjusted manually and individually to obtain an optimal air distribution.

### Technical information

#### Characteristics:

- double row of vanes
- free passage ca. 70% (depending on the position of the vanes)
- available in multiples of 25 mm, in length as well as height

#### G-130:

min L=75 mm, max L=2000 mm  
min H=75 mm, max H=1200 mm

#### A-130:

min L=100 mm, max L=2000 mm  
min H=75 mm, max H=2000 mm

- linear grilles (=grille in multiple pieces, consisting of intermediate and end pieces), only available in heights 75, 100, 150, 200 and 300 mm
- also available in 35 mm margin width (only in aluminium construction)

#### Construction:

- **A-130** : frame in extruded aluminium; vanes out of aluminium roll-formed sheet; both are satin anodised
- **G-130** : completely in roll-formed sheet steel and painted in white (RAL 9010)

## Specifications description

### Example:

Steel supply grille with vertical and horizontal, individually adjustable vanes for wall or exposed duct mounting, equipped with a damper. The grille is painted in white (RAL 9010)

**Type: GF130 + GT007**  
nom. dim. (LxH) ... x ...mm

## Accessories

- **GT003**: perforated steel plate 35% passage, painted black (RAL 9005)
- **GT007**: damper with vertical, opposed blades.  
construction of galvanised sheet steel, painted black.  
(For further details, see p. 1 290)
- **GR001**: mounting frame of roll-formed, galvanised sheet steel  
(only for AD/GD and AE/GE)

## How to order

GE130, dimension 600 x 200 mm, with damper GT007 and mounting frame GR001

### a) Grille

G	E	1	3	7	-	-	0	6	0	0	0	2	0	0
---	---	---	---	---	---	---	---	---	---	---	---	---	---	---

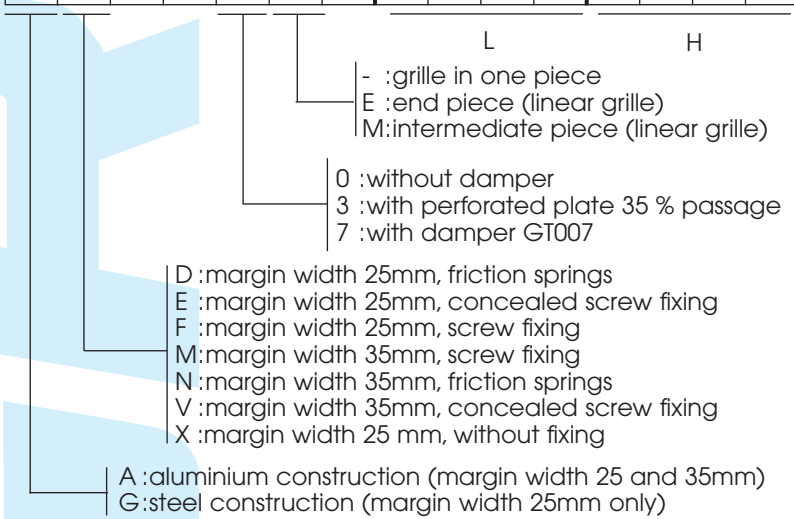

### b) Mounting frame

G	R	0	0	1	-	-	0	6	0	0	0	2	0	0
---	---	---	---	---	---	---	---	---	---	---	---	---	---	---

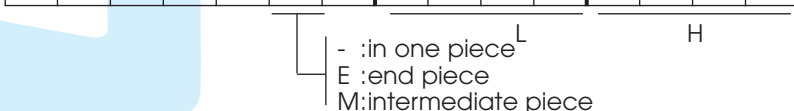

## GRILLE WITH ADJUSTABLE VANES A-130 • G-130

### Fixing methods

#### AF130/GF130

Grille with visible screw fixing

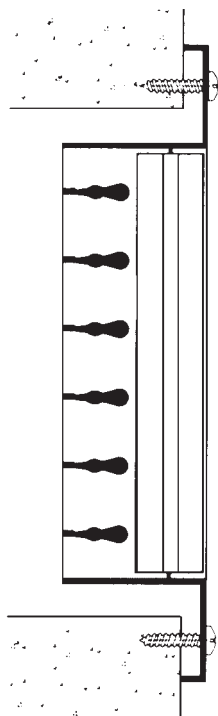

#### AE130/GE130 + GR001

Grille with concealed screw fixing and mounting frame

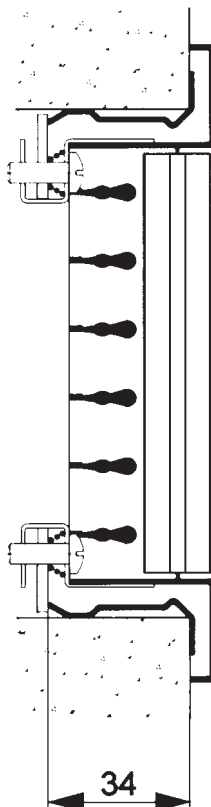

#### AD130/GD130 + GR001

Grille with friction springs and mounting frame

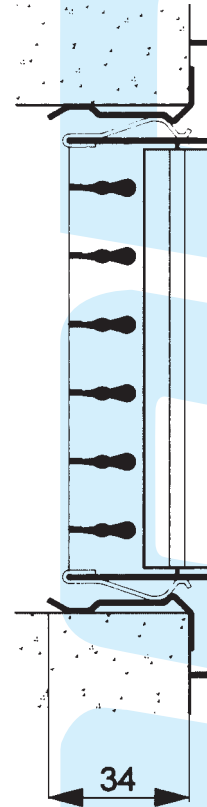

### Possible deliveries

Grille with double row of vertical front and horizontal back vanes :

Aluminium	Steel	Construction
AD130	GD130	friction springs (not available for linear grilles)
AE130	GE130	concealed screw fixing
AF130	GF130	visible screw fixing
A-133	G-133	with perforated plate GT003 35% passage
A-137	G-137	with damper GT007

